

Donald A. Smith—W3UZN
Associate Editor

73

Tests

HEATHKIT "Twoer"HW-30 Two Meter Transceiver

Size: 7" x 9 $\frac{3}{4}$ " x 6" deep.
Weight: 6 $\frac{1}{2}$ lbs.
Power: 115 vac @ 45 watts.
Transmitter: 8 mc xtals.
5 watts input.
Receiver: Super-regenerative.
RF amplifier.
Tunes 144-148 mc (CAP
& MARS).
Assembly Time: 7 hours, average.
Price: \$44.95 (including mike).

If you'd like to know more about a complete 2 meter station for less than \$45.00, read on! Latest in the Heath Company's line of low priced transceivers is the HW-30, a two meter model, similar to the ten and six meter models. The size, shape and color of all the units are the same, though the insides of the Twoer are somewhat different.

Transmitter

Regular 8 mc crystals with standard .500" pin spacing (FT-243 holders), are used in the oscillator. The pentode half of a 6BA8 tube is used as the oscillator in an electron coupled, Pierce oscillator circuit. The plate circuit of the oscillator is tuned to 24 mc, thus tripling in the oscillator. The second half of a 6BA8 (triode) takes the 24 mc output from the oscillator and triples it to 72 mc. The 72 mc signal is then fed to the triode half of another 6BA8 tube which doubles the signal to 144 mc and drives the final. The pentode half of a 6BA8 is the final, operating straight through on 144 mc.

Bypassing in the transmitter is extensive, with over two dozen ceramic disk capacitors being used! All tuning in the rig is done with slug tuned coils, with the exception of the final, which is tuned with a 2.5 to 6 μ fd trimmer capacitor. The final coil is mounted right on the trimmer proper, to keep the lead length as short as possible.

Plate modulation is used, which gives you more "punch" than other types.

Receiver

The receiving section is very sensitive, even though a super-regenerative detector is used. Heath has improved on the standard super-regen by adding a tuned rf stage. A low noise 6BS8 tube is used in the receiver. One triode of the tube is used as the rf amplifier and the other triode as the super-regen detector. Some Amateurs have never used the super-regen, so I will mention that one of the problems with them that has always been annoying, is what is known as "suck-out." That is, as the receiving frequency is changed, the detector will drop out of oscillation.

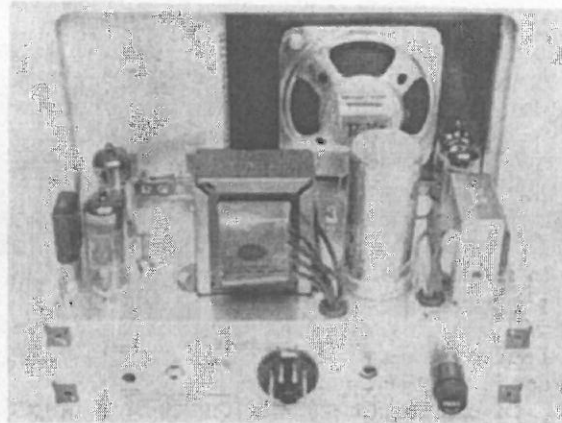

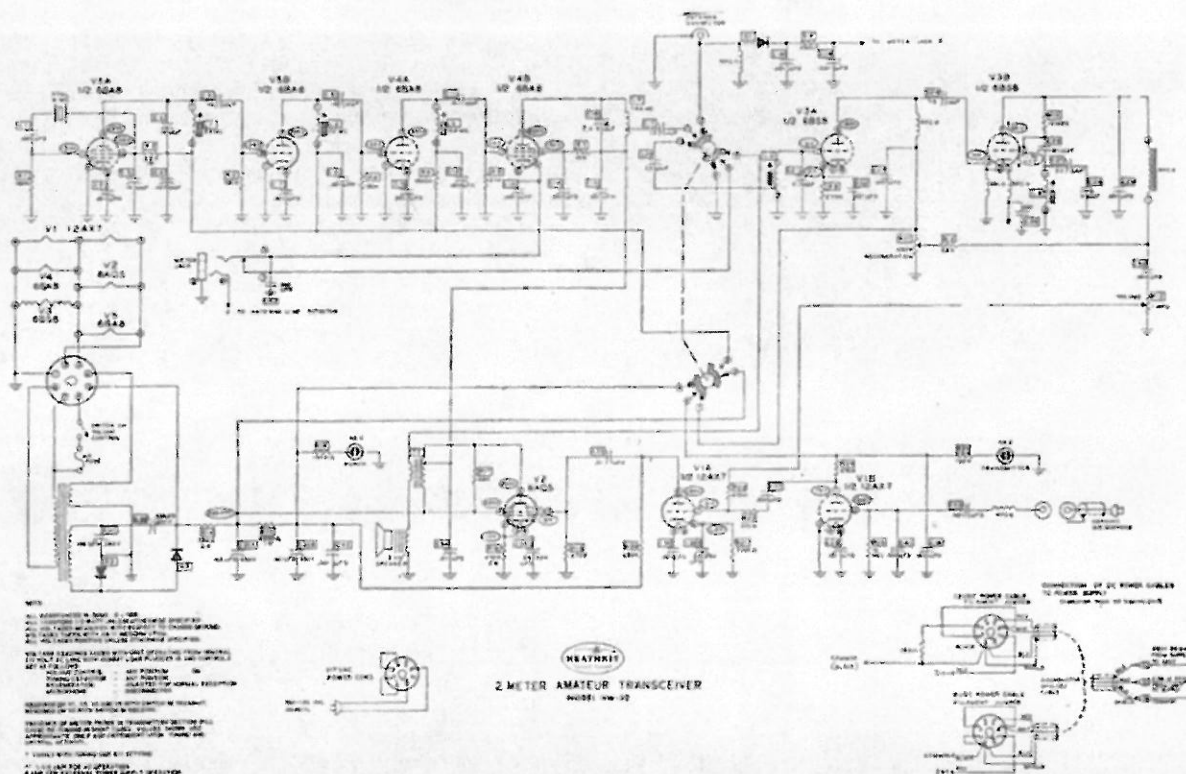

Heath has eliminated this problem in two ways. First, they use impedance coupling between the rf amplifier stage and the detector and secondly they made the feed point of the detector a very low impedance. Thus when the regeneration control has once been adjusted properly, you can tune between 144 mc and 148 mc without any further adjustment of the regen control. It should also be mentioned that the super-regen is famous for re-radiating signals from the receiving antenna. The rf stage minimizes this re-radiation.

Audio

On receive, the audio section includes one half of a 12AX7 as a voltage amplifier, feeding a 6AQ5 output tube. A 3½ inch speaker is mounted on the front panel of the unit. One watt of undistorted audio is available in the receive position.

On transmit, the audio section becomes the modulator. One half of a 12AX7 tube is used as a mike pre-amplifier and the second half of the 12AX7 is used as a voltage amplifier, driving the 6AQ5 output tube. A tap on the output transformer is used to provide the proper impedance for the final rf amplifier, plate modulation being used. An rfc and .001 disk ceramic capacitor are used in the mike input to the modulator, preventing rf energy from re-entering the audio section during transmit.

Power Supply

A built-in ac power supply is included with the transceiver, using a power transformer.

A full-wave voltage doubler circuit is utilized, using two silicon diodes. B+ output is approximately 260 vdc @ 90 ma. The supply is wired in such a way that an external dc supply can be plugged into the rear of the unit and all necessary changes in the rigs circuitry are automatically changed over when the proper cable is plugged into the rear of the unit.

Building the Unit

Building the rig requires 6 or 8 hours to complete and should NOT be hurried. The design and layout has been carefully thought out, as long leads, parts placement and general layout become quite critical at these frequency. All capacitors used in the rf circuits (both receiving and transmitting sections), are disc ceramic and even tube sockets are of the ceramic, shielded types, for low loss. Note in the photos, that the bottom of the unit looks like there are hardly any parts used in the unit. It gives this appearance because the lead length was kept as short as possible. Actually there are 42 capacitors, 25 resistors, 8 terminal strips, 2 controls, 1 rotary switch, 6 rf coils and 6 rf chokes under there!

The filament circuit and the B+ wiring is done first, with the transmitter section following. The receiver section is then wired, with the power supply and front panel wiring done last. Parts are furnished for making one ac and one dc (6 or 12 volts), power cords.

Tune Up

The rig, as mentioned before, uses 8 mc xtals and when it comes to tuning up the rig, you're

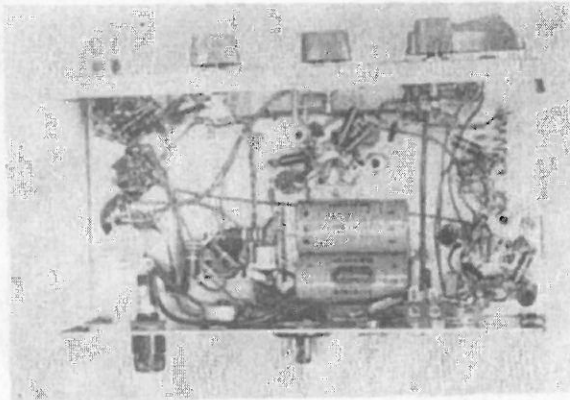

glad it does as there are no tricky crystal feedback adjustments, or troubles with lack of "drive." To make the tune-up even easier for those not too familiar with these frequencies, approximate settings of all the coil slugs and the final tuning capacitor are given in the tune-up procedure.

(See diagram.) The oscillator is tuned to 24 mc with the slug in L1 being used to make the adjustment. The tripler is then brought to resonance with the adjustment of L2. The doubler can then be tuned by adjusting L3. The final is dipped by adjusting the final tuning capacitor, C16. There is only *one* dip possible in the final! The two meter model has a little different set-up on the meter plug than the other two models. The Twoer uses a two circuit jack, the first position being used to measure the rf output voltage with a standard dc VOM or VTVM. When the unit is tuned properly this voltage will be about 14 or 15 volts on a 20,000 ohms/volt meter. A diode and filtering circuit is built into the rig to provide this reading, which is helpful in tuning up the rig.

When the meter jack is pushed all the way in, (to the second position), the meter is placed in series with the final amplifier, permitting the final plate current to be read. Please NOTE that the meter can not be left plugged into the second position of the meter jack, unless the rig is actually switched to transmit (on the front panel), as the meter completes the final cathode circuit to ground and the final will be operating regardless of the front switch setting.

Receiver tune-up is very easy and a GDO, signal generator, or an on-the-air, two meter signal can be used. The adjustments include rf amplifier tuning, detector tuning and regeneration control adjustment. The receiver adjustments affect each other slightly, so the other adjustments must be checked after making any adjustments to the receiver coils or the regen control.

Checking Out the Rig

I have to admit, frankly, that I was really surprised at what the rig will do. The first station worked was about 45 miles away, on

the *other* side of 1200 foot mountains and the signal report was 59! To top it off, I was using a six meter beam at the time! Later, working the same station with a two meter beam, signal reports were 59+++ . There is no drift with the rig, nor any FM and modulation quality is excellent.

The receiver section is very sensitive and signals were heard often from Washington, D.C., Alexandria, Va., etc. Selectivity is nothing to rave about, as would be expected with this type of receiver. On the VHF bands this is seldom important. And for mobile use the rig really fills the bill.

The VP-1-6 (or 12), vibrator power supply is designed for Heaths' line of transceivers and one of these supplies will operate the 6 or 10 meter models from a six or 12 volt battery. The Twoer requires two of these supplies, however, as the B+ current runs about 90 mils on transmit, while the other models runs about 60 mils. The supplies are quite inexpensive, at 7.95 each in kit form, complete with tube and vibrator!

The six and ten meter transceivers can be bolted together, along with the Twoer to provide a complete 10, 6 and 2 meter VHF station for about \$130. A single meter can be used for all three units when they are connected together.

All in all, there is a lot of fun to be had with the little Twoer. At \$44.95 it sure is an inexpensive way to get on two meters. It is my personal hope that the rig will encourage others to come up on the higher bands.

... W3UZN



VFOing the Twoer

Paul Snyder WA3HWI/3
900 Valley Road
Philadelphia PA 19126

Many of us 2 meter QRP diehards are using the Heathkit Twoer, a little 5W transceiver. Aside from 100 kHz receiver selectivity, we also wish for vfo control. Thank your local apostle, here's how.

Step 1: Get a vfo. This isn't too hard; the Knight V-107 vfo is perfect. Its output is about 15V, just fine for the Twoer. Build a separate power source supplying all the voltages that it needs.

I'm using the Heath HG-10B vfo. A few modifications are necessary. In the Twoer, add a .001 μ F 1 kV capacitor from pin 8 of V5A to ground, and change R2 from 22 k Ω to about 18 k Ω . Now the tube is an amplifier for the vfo instead of an oscillator. The vfo input goes directly into the pin 7 side of the crystal socket.

In the HG-10B, connect a shorting wire across the 10 k Ω , 10W resistor, and change the OB2 to an OA2 or OD3A. Build a separate power supply, with a filtered 175V dc, at about 30 mA, 6.3V ac or dc at 1A, and -70V bias, as shown in Fig. 1. The bias is connected via the green wire of the HG-10B. On terminal strip A, disconnect the green wire from terminal two and solder it onto terminal three. Remove the jumper on the key jack, between terminals two and three.

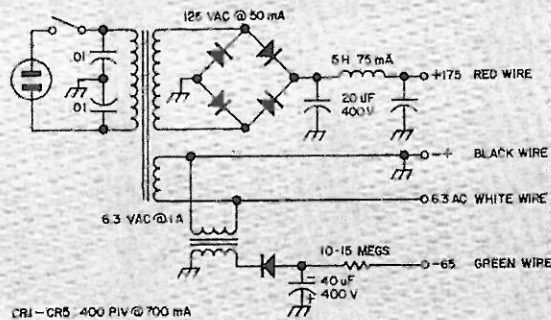

Fig. 1. Schematic

The second wish is to increase the selectivity of the Twoer. Simply change R10 to anywhere between 20 and 30 M Ω . (It's the one mounted on that big coil in the center.) This will change the calibration but not the sensitivity of the receiver.

My thanks to W. J. Remer K8GND, of the Heathkit technical staff, for his help in the modification of my Twoer.

...WA3HWI

Bud Michaels WB2WYO
713 High Street
Victor NY 14564

Push-to-Talk for the Sixer

AND OTHER MODIFICATIONS

Breathes there an owner of the "Benton Harbor Lunchbox" who hasn't made some modifications to suit his own needs? My Sixer is mounted in a Volkswagen for mobile operation, and I found it hazardous while driving to manually change from receive to transmit using the panel-mounted switch. So, out came the rig for a push-to-talk modification. And while the little fellow was sitting on the workbench with its innards exposed, a few others changes were made: a spot switch and receiver bandspread. These modifica-

tions, plus others that had been made from time to time (the output meter and front panel mounted crystal socket were installed following articles in various ham publications over the past few years), have made the Sixer a real joy to operate. I'm sure the basic ideas described here would apply to the Twoer as well.

Push-to-talk capability was achieved by replacing the manual transmit/receive switch with a 12V dc 4PDT miniature relay. Owing to the nature of the filament circuit, once you've converted the rig to PTT, you can't operate on 115V ac, because the filaments are fed in parallel from a 6V winding on the transformer, and when operating from 12V dc, they are arranged in a series-parallel circuit. Since I intended only mobile operation, this situation did not bother me. Since the filaments operate on 6V, a 6V ac or dc relay across the filament string may be used for the PTT, depending upon whether you prefer fixed or mobile operation. People who use these ubiquitous rigs both at home and in the mobile might try installing a rectifier in the filament string before an appropriate dc relay.

The relay is mounted upside down and against the front skirt of the chassis, using contact cement. No socket is used. The

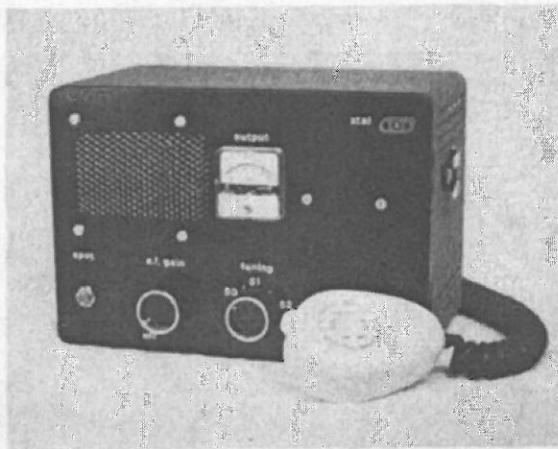

Author's "Sixer" ready for mobile operation. New panel is not essential but helps to cover up hole left by removed transmit-receive switch. Note new tuning scale.

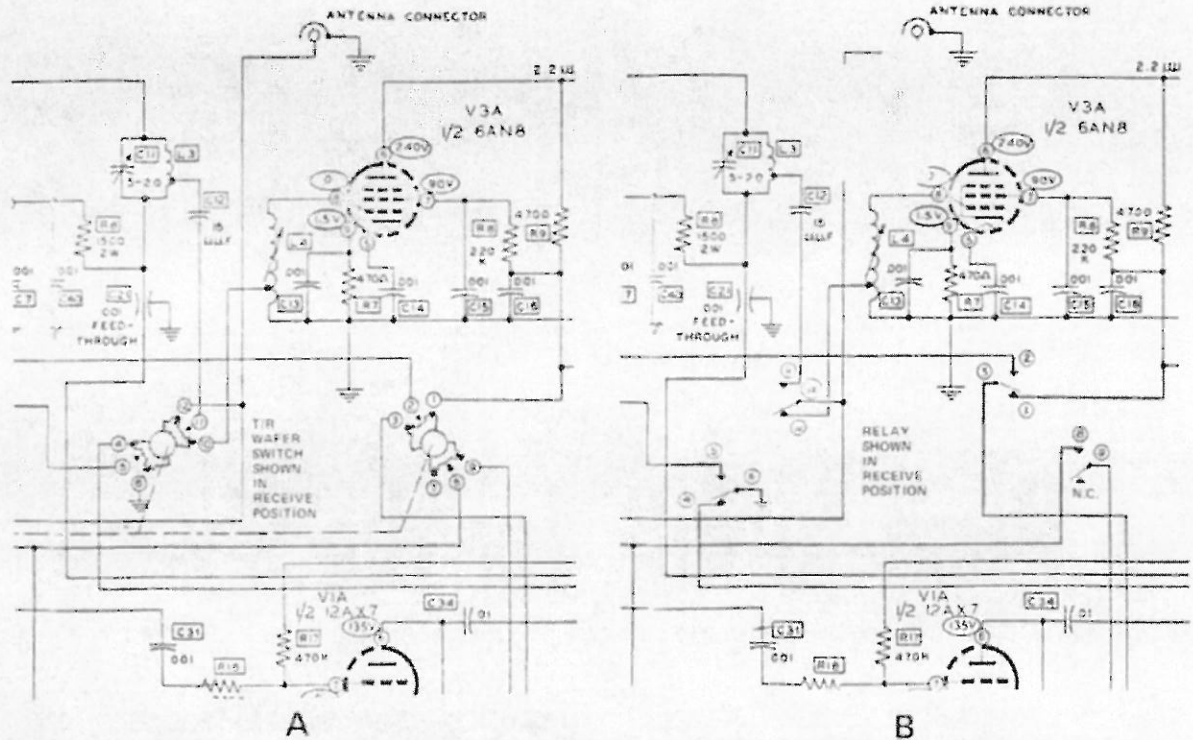

Fig. 1. (a) T/R circuit before modification. T/R wafer switch shown in receive position. (b) T/R circuit after modification. Relay shown in receive position. Numbers in circles around relay contacts correspond to original terminals on wafer switch.

relay occupies the same area originally taken by the wafer switch (see photo), which makes wiring rather easy; just use the wires you removed from the wafer switch and connect them to the relay. Figure 1 shows a "before and after" wiring scheme based on the original Heathkit schematic diagram.

I was a bit apprehensive about making this change, as I felt the intercapacitance between close relay contacts might adversely affect rf output. Before making the change, I measured rf output across a 50Ω dummy load, then repeated the measurements after the relay was installed and the final amplifier retuned. Using my simple measuring techniques, I could detect no reduction in rf output.

Voltage to operate the relay is taken from the 12V filament circuit. Figure 2 shows the relay actuation circuit. The relay is operated by a microphone with a push-to-talk switch built in. A suitable microphone jack can be installed in place of the original jack on the front panel, or on the rear skirt, if you want to add the spot

switch described next. Since my Sixer has an output meter, I removed the meter jack and reamed out the hole on the rear skirt to accept the microphone jack. Be sure to use a high impedance microphone.

I can't say the spot switch I added lets you pinpoint your crystal frequency on the dial, owing to the very broad tuning characteristics of the receiver. But it is a help when there are several stations around your operating frequency, and you want an inkling of where your signal is going to fall. A SPST (momentary-make or standard toggle) switch is mounted on the front panel and connects a 47,000Ω, 1 watt

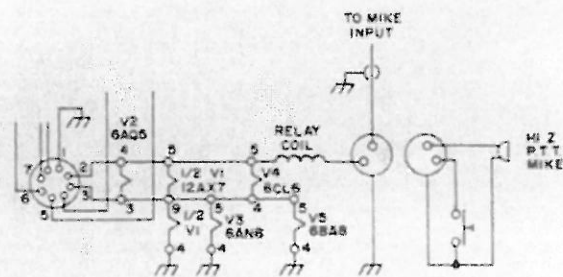

Fig. 2. Relay actuation circuit.

7

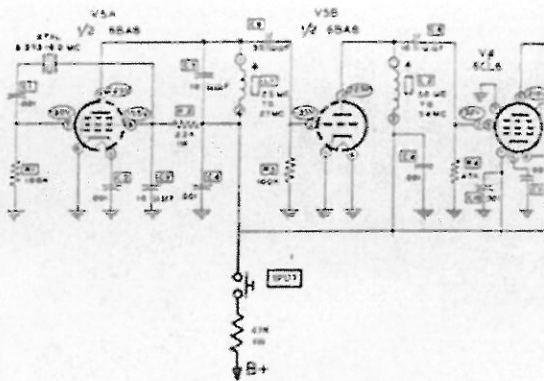

Fig. 3. Spot switch circuit.

resistor between a source of B+ and the plate of oscillator tube V5A, as shown in Fig. 3. The resistor keeps the plate voltage low enough so the oscillator output doesn't overload the receiver, and tends to make spotting a bit more accurate. (Even with this reduction in output, the spot signal covers about 15 degrees of tuning dial rotation!) The broad tuning and lack of selectivity led to the next modification — bandspread.

Bandspread

Most of the activity on six meters in my part of the country seems to fall between 50.2 and 51 MHz, with a great concentration of stations around 50.4 MHz. With the Sixer covering 50 to 54 MHz, this meant that most of the stations I work fall within a two degree span of the dial. Ridiculous!

I very carefully removed one of the two rotor plates from the receiving tuning capacitor, then soldered a 1.5 to 8 pF trimmer across the capacitor terminals. I adjusted the trimmer so that the receiver tuned from 50 MHz to around 52 MHz.

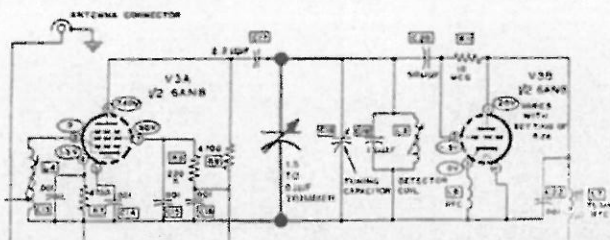

Fig. 4. Bandspread circuit.

**ELECTRONICS LATEST
TROUBLE SHOOTER**
a compact-complete
circuit analyzer
The SERVISSET

Model EC
Patented
introductory
price **\$34.95** postpaid

A precision engineered professional quality electronic test instrument. Ideal for field or bench servicing of all types of Communications gear.

CHECKS: sync, sweep, video, audio circuits, high voltage supplies (DC, RF or Pulse), low voltage supplies, coils, capacitors, resistors, tubes, transistors, diodes, transformers, speakers, etc. Will locate trouble to a particular stage, determine defective component and can actually be clamped in circuit to restore circuit operation temporarily in 80% of component or tube defects. Ideal for locating and confirming intermittents.

SPECIFICATIONS:
RF & AF Signal Tracer, RF & AF Signal Injector, AC & DC Voltage Indicator 0/60/550/20,000 DC Polarity Indicator 60/550/20,000 volts, Lo ohms 0-5 Hi ohms 0-500k-20 megohms. Tests Condensers, .00025-12 mfd., Tests Resistors 2 ohms-20 megohms, 2 Capacitance Sub ranges .01-1 & 4-40 mfd., 3 Resistance Sub ranges 50-500 ohms, 5k-25k, 100k-1 meg.

30 Day Money-Back Guarantee
LEE ELECTRONIC LABS. INC.
88 Evans Street
Watertown, Massachusetts 02172

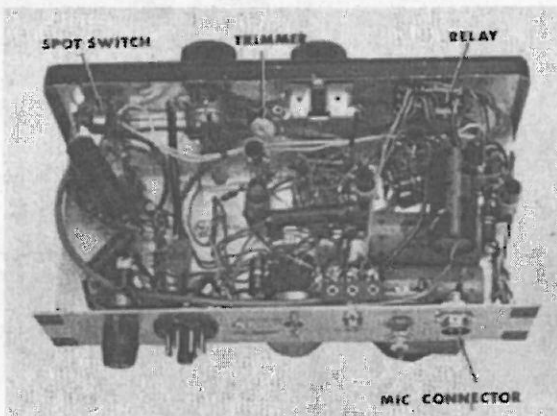

Sixer underchassis shows location of added components.

This doesn't really change the selectivity characteristics; it merely spreads the stations out a bit. It does make a difference when mobiling, however, and I found it to be worthwhile. Figure 4 shows the circuit change.

My thanks to Bob Wille, K2RQU, for his help during testing the modifications, and to Court Packer for his photography.

...WB2WYO■

Ralph Orozco, Jr. WB6FVW
2081 Bolero Avenue
Hayward CA 94545

VFO OPERATION FOR THE TWO'er

This article may be of some interest to newcomers in the 2 meter band, or even some amateurs who might be tired of being rock-bound. Maybe you might want to check in on a club net, or break in on an interesting QSO. Vfo operation would be handy on Field Day, or to do a little DX chasing. If you were to buy half a dozen crystals or so, you would have spent enough money to build a good solid-state vfo or perhaps buy one cheap at a club auction.

For this article I used the equipment on hand, which was a Heath HG10 vfo and a Twoer (HW30). The receiver being what it is, there is a disadvantage not being able to spot the vfo frequency on the B-R-O-A-D regenerative receiver. There is a way to solve this broadness. If you haven't already converted your Twoer receiver, as described in an article titled "More Selectivity For The Twoer" in the June 1963, 73 I recommend the conversion. It is well worth your effort! It makes the receiver usable.

I might add that several members of the Hayward Radio Club, including myself, use Twoers on the club net, with the receivers converted as described in the article. We are very satisfied with the results.

The vfo coupling circuit description is simple and parts cost little or nothing. The HG10 vfo covers 80 through 2 meters and is a fairly stable vfo. The output circuit is a low Z cathode follower, with a common ground return. The Twoer uses a Pierce oscillator which does not have a common ground on the crystal oscillator.

This means that the vfo output cannot be directly coupled to the Pierce oscillator.

The vfo was link coupled to an 8 MHz series tuned tank for load isolation and impedance matching. I found it necessary to isolate the 8 MHz tank from the screen dc voltage in the Twoer. C1 of the 8 MHz tank is the dc blocking condenser. The 8 MHz tank was built on a crystal socket holder, so it could simply be plugged in and out.

Perhaps you might want to make a more permanent setup and use a DPDT switch. One thing of importance is to make sure the one turn link is kept from moving once the tank is tuned. The 8 MHz tank is sharp and moving the link will cause detuning. Keep the link secured well.

Tune the 8 MHz tank for resonance in the middle of the band. The length of the output cable from the vfo will change C1 somewhat from the value shown.

The method used for spotting the vfo frequency on the receiver is to key the Twoer oscillator coil (L1) and the B+ from the transmit function switch. In the forward direction, the transmitter with the diode works normally. In the reverse direction, it keeps B+ from the rest of the transmitter circuit when the oscillator is keyed. I might add, other types of vfos could be used with the Twoer as long as the coupling circuit remains the same.

As a final comment, I also cannot see why the Sixer (HW29A) will not work with a vfo the same as the Twoer, since the circuit is basically the same.

...WB6FVW

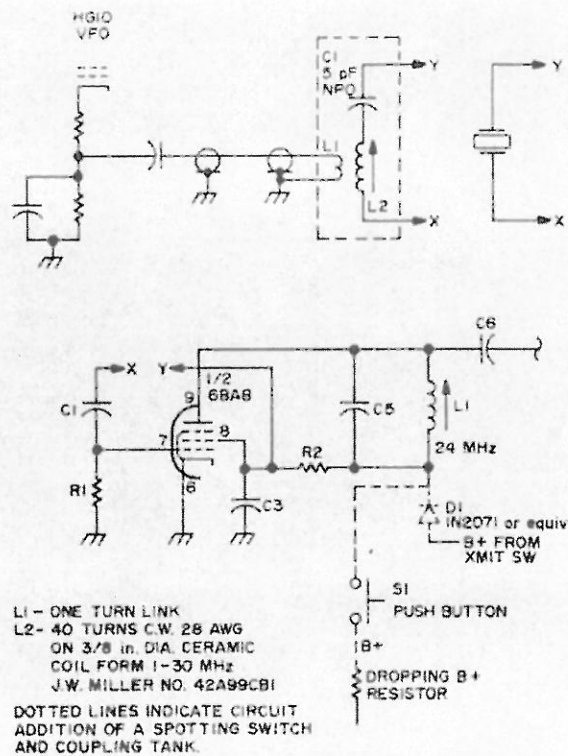
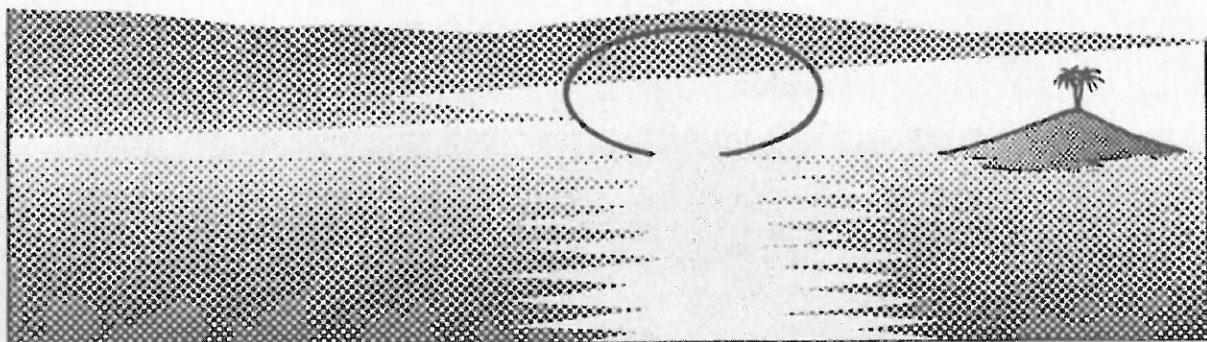

Fig. 1. MHz series tune tank.

ANNOUNCING THE 73 DX-PEDITION TO BAJO NUEVO HKØ

Join Wayne Green, W2NSD/1 and Keith Lamonica, W7DXX/1 as we operate from BAJO NUEVO. Picture yourself next November operating HKØDX from a tropical island in the Caribbean. We still have room for good operators. If you would like to be part of the 73 DX-pedition to BAJO NUEVO, Call Keith, W7DXX/1 at 603-924-3873 for details. HURRY!



The Genius Takes to the Air

Then I got my ham ticket. That really did it! When my roof began sprouting weird antennas, and the neighbors' TV sets began acting in a strange manner, they were more convinced than ever that another Steinmetz was their private electronic consulting engineer. I was asked about everything from ailing TV sets (I carry service insurance on my own set) to improperly operating electric blankets (when mine quit recently, I bought a new one). And it doesn't end there; I've even found myself answering questions on the air about how to plate-modulate a transmitter, or how to eliminate chirp on CW. Sometimes I have some idea what I'm talking about, but certainly not always. However, if I tell them I don't know what I'm talking about then I am considered overly modest; if I offer no suggestions, the conclusion is that I don't care enough to even think about the problem. A dilemma. I have found it easier to give them an answer they don't understand than to try to convince them that I'm talking through my chapeau.

The Genius Goes Stereo

Take the other night, for instance. Andy, who has known me long enough to know better, brought over a stereo tape recorder he had just built from a kit . . . his first tussle with electronics. He said that the left channel was dead. Not being a tape recorder specialist, or any other kind of specialist, I did the only thing I could think of at the moment; I plugged in the "kluge" and turned it on. Music poured forth from both channels, loud and clear. "What did you do to it?" Andy asked.

"Nothing," I replied.

"There you go being modest again," he said. "All you electronic geniuses are alike."

Then we tried to record. No erase. So I unbuttoned the whole works and looked at the maze of wire and stuff and things inside the chassis. I noticed two shielded cables from the erase head terminating in two plugs on the chassis. On a wild hunch (my usual method) I swapped the two plugs in their sockets. This cured the trouble. To Andy this was sheer wizardry. When I tried to explain the four-track stereo tape system, and the operation of the record and erase oscillator, he absorbed about as much as a third grader trying to learn the Pythagorean Theorem.

That's about the time the left-channel playback went dead. I had no recourse but to resort to the scientific approach. Using the dirty wooden handle of a small, dirty paint-

brush that happened to be laying on my dirty workbench, I pushed and shoved everything in sight under the chassis. Responding to this precision trouble-shooting technique, the left-channel burst forth in full bloom. More probing disclosed that a single strand of shielding had lodged itself against the grid of the left-channel pre-amp tube!

Now the left-channel magic-eye record level indicator tube was acting oddly. Andy was obviously *right-handed*! No amount of pushing and shoving with the paintbrush handle did any good. This exhausted my supply of magic tricks, so I suggested that we put the whole works back in the case and be glad that it hadn't gone up in smoke. All buttoned up, we gave it the final check. No one was more surprised than I when everything worked, including the left-channel magic-eye indicator! "You did something when I wasn't looking," accused Andy.

With a knowing expression, I replied, "The hand is quicker than the 'eye,' my friend . . ."

. . . K6UCT

Squelch for the Twoer and Sixer

Richard Koenig WØTWP
3 Ladue Ridge Road
St. Louis 24, Mo.

The amazing little "Benton Harbor Lunch Bucket" is a very popular transceiver and is found in practically every ham shack for communications of one type or another.

Although their performance is excellent, the characteristic hiss noise from the super regenerative receiver can be somewhat annoying while monitoring for any length of time. A good squelch, all will agree, would make the little beasts much more enjoyable during standby, while awaiting a signal.

This sensitive and 100% effective squelch has been used by the author and several friends with great satisfaction, both mobile and fixed. If you have a TWOER or a SIXER, we would like to share our enthusiasm with you.

QUEMENT

HOT SPECIALS!

BRAND NEW GONSET
SUPER-12 SIX BAND
CONVERTERS

\$39⁹⁵

(Reg. \$89.50)

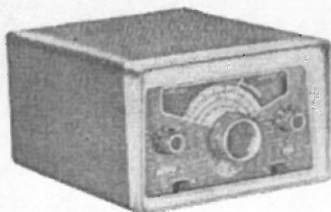

BRAND NEW
GONSET GC-105 **\$199⁹⁵**
TWO METER
COMMUNICATORS (Reg. 272.95)

SINCE 1933

• ONE DAY SERVICE

• Phone CY 4-0464

QUEMENT ELECTRONICS

1000 SOUTH BASCOM AVENUE

SAN JOSE, CALIFORNIA

"Northern California's Most Complete Ham Store"

Here is how it works. The annoying hiss noise, which has its main components above 8000 cycles per second, is considerably higher in audio frequency than the audio modulation frequencies of an incoming signal. This hiss, which drops in level when an incoming signal appears, is used to actuate the speaker killing circuit.

The receiver audio signal, taken from the audio output transformer primary tap, is passed thru a high pass filter, rectified and applied as a negative control grid voltage to a 6AV6 dc amplifier. With no signal present the high negative grid voltage, created by the high hiss level, reduces the plate current of the 6AV6, which opens the plate relay, killing the speaker. When a signal appears, the hiss level of the receiver decreases and lowers the negative grid voltage to the 6AV6. This causes it to draw higher plate current and closes the plate relay, actuating the speaker.

The squelch threshold control, R1, is adjusted to bias the grid circuit of the 6AV6 to hold the relay just open, with no signal present. For any chosen volume control setting, there is a point on R1 which will set the squelch at the edge of the threshold.

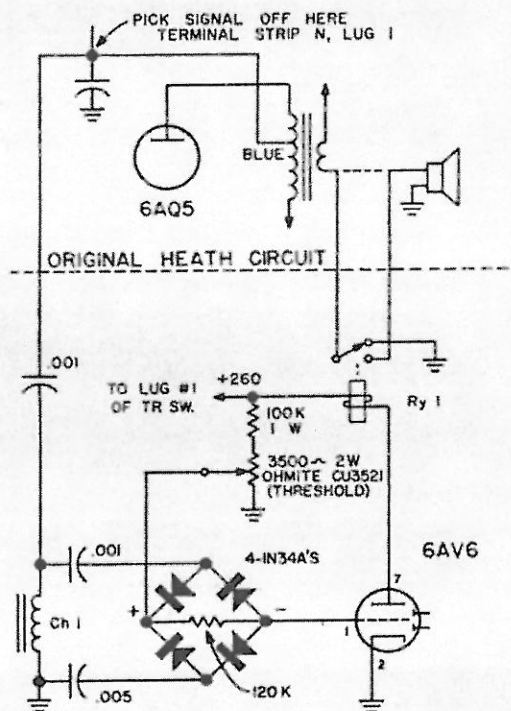

APPROXIMATELY 3 Mc. ACTIVATES Ry 1

RY.—spdt relay 10,000 ohm P.B. type RS5D
CH.—.250 by r1 choke Suprex Varichoke V-70

Although very suitable for outboard arrangement, since only power and three leads are involved from the transceiver, the squelch has proved so satisfactory that it has been installed on the chassis of each set used in the pioneering and tests. The threshold control mounts on upper front panel, the relay on a piece of plastic mounted on speaker bracket and the 6AV6 on the chassis between the filter can and the 6AQ5. Well worth the effort.

The use of a Vector lug type socket for the 6AV6 enables all small components to be mounted and wired directly on the socket prior to mounting. A reminder may be in order to leave some length on the diode leads to protect them from heat while soldering. The 250 mh choke should have its adjustable core fully engaged. This allows the filter network to pass

8000 cps and higher. The dc output of the diode bridge rectifier, as measured at the + - signs on the schematic, should read approximately 12 volts with the volume high and no signal tuned in. (20,000 ohms per volt meter used)

For the best stability, the regeneration control of the transceiver, R11, should be advanced to near maximum. L5 and L6 can be adjusted, with the meter connected, to make the no signal control voltage constant across the entire dial.

Due to its unique principle of operation, this squelch is not triggered by normal noise or automobile ignition, which proves to be a pleasant feature while mobiling or operating in a noisy area.

... WØTWP

\$25 Cheap

Leonard Tamulonis W1MEL
73 Staff

It was a bargain at any price! Thirty feet tall, three-legged, solid steel, and all mine for twenty-five dollars cheap. It was the best darned windmill turned radio tower I had seen in a long time. How did I get this gem? Well, it seems that one of the local boys had gotten orders to paint his tower, or his XIL swore she would plant a petunia and clinging vine jungle all over it. Since he didn't have money for paint (he'd sunk his allowance into a pair of 813's) and couldn't stand the humiliation of trying to prune Morning Glories to fourteen megacycles, he decided to get rid of it . . . and li'l old me was standing right beside him when he did.

A bargaining period over a bottle of brew brought the price to the aforementioned twenty-five dollars, along with a fifteen meter beam thrown in with the tower for chuckles. Now came the problem of moving the thing.

Getting this cargo clear across town to the QTH was not going to be an easy matter, but a quick call to a friend in the concrete block business brought the loan of a twenty-foot open truck. Block and tackles, ropes,

chains, cases of beer, and whatnot were all assembled, and we waited for the following Saturday morning when we'd rise bright and early to face the task of moving said tower to Fulton Street.

There were six of us that fateful morning . . . the other three had shown up to kibitz, watch, and generally make trouble. It was immediately decided to hook a block and tackle to the top of the tower, and string it to the top of a nearby tree. In this way all we had to do was tip the tower and slowly let out the line until the tower was gently set on the ground. But of course it never happened that way. After getting all set, the tower was tipped, and the block and tackle slowly let out. By some miscalculation Joe Gooberduck was stationed at the pulley rope. Now Joe is not the type to be put in such a position, because he's only five feet three, 113 pounds and underfed. So down came the tower, and up went Joe.

After the dust had cleared, Joe was nowhere in sight. He was stuck high up in the nether regions of the tree, with the pulley rope

John W. Myrna WA2QZH
222 Franklin Avenue
Wyckoff, N. J., 07481

Getting the Most from Your Two'er



Back in April of 1961, when my Novice License was but two months old and a newly earned 15 wpm C.P. Certificate graced my wall, the fone bug bit me. Upon the recommendation of WA2SAB, who worked nine states with one, I bought a Heathkit Two'er.

One of the first problems that came up after the rig was put together, other than some debugging that I'll mention later, was the inaccessibility of the crystal socket. Taking off the case every time I wanted to change frequency just took too much time so down I went to my workshop for a hacksaw and drill. I hate to disfigure equipment so I decided to do a neat job. The license holder on the side of the Two'er is held on by three or four rivets and if a screwdriver is wedged between the license holder and the main case a little leverage will "pop" the holder off.

After removing the license holder, flatten it to its former shape if it is bent in the operation, and set it aside. With a hacksaw or saber saw cut the unpainted area exposed by the removal of the license holder. Be sure to leave a $\frac{3}{8}$ inch border on the bottom so the hole you cut remains above the chassis.

Now trot down to the hardware store and buy four inches of piano hinge. Attach $\frac{1}{2}$ the hinge to the top of the license holder, after drilling suitable holes, and attach the other half of the hinge to the case through the lowest set of air holes above the hole cut in the side of the case. I typed up a little plate giving my name, address, call, etc. and put it in the license holder thus identifying who owns the rig and at the same time covering up the rivet holes. With the trap door I can now change crystals, final tubes, and adjust

the transmitter stages. It's also a handy place to tape a couple of spare fuses.

The only transmitter control that needs frequent adjustment is the plate tuning capacitor (C16) which is just below the chassis. Drill a hole in the case over the capacitor and install a rubber grommet in the hole. In this way you can adjust the transmitter tuning with a small screwdriver. CAUTION: There are 150-200 volts on that capacitor so don't touch the metal part of the screwdriver and ground or you'll get a nice little shock. The grommet will prevent the screwdriver from shorting against the case. You'll find that the "trap door" will cover the grommet hole and the crystal hole making a neat job.

When tuning up the transmitter an output meter is essential. A meter mounted on the front panel is more convenient than one plugged in the back, especially when mobilizing. Any meter with a sensitive movement will do, but if O-Ima movement is used, the S-Meter circuit used in the July 61 issue of 73 can be incorporated with the output circuit.

The best place to put the meter is in the space now occupied by the Heathkit emblem. Center the meter hole in the clear space there and cut away. A masonite hole cutter will go through the aluminum front panel like it was cheese, by the way. Connect the meter through a variable resistor to meter jack Z. See Fig. 1. The pot can be taped to the back of the meter and used to "set" the meter. Run the ground lead from the meter to the ground lug on the neon light terminal strip just below it and you're all set.

One possible cause of feedback in the

Two'er is the long lead between the modulation transformer and final. Replacing this lead from terminal strip N1 to strip S4 with shielded cable cleared up the feedback problem for WA2FFB and K2GHU, it could for you, too.

The screwdriver adjustment on the regen control was a bother so I replaced the pot with one with a small knob.

The phone plug used for an antenna jack is fine for base station use, but if you do any mobiling you'll find that the antenna cable keeps pulling out of the phone jack. The best connector to replace the phono jack is the Dow-Key Model DK60-P panel mounting coax connector. All you have to do is enlarge the old antenna jack hole and screw the new Dow connector in.

If you switch between mobile and fixed station use a lot, the chore of changing fuses can trip you. Forget to place a 8 amp mobile fuse in and the 1½ amp ac one will blow. Forget to put back the 1½ amp fuse when you take the rig out of the mobile car and you lose your fusing protection. WA2WZP got around this by putting a fused line plug on the ac cable and leaving the mobile 8 amp fuse in the Two'er. This way the proper fuse is always in the rig whether the ac or mobile cables are used.

If you desire to make the Two'er transmitting audio even better you can use this modification that worked wonders on WA2UCC and WA2WZP's Two'ers. Remove pin 3 of V1B (12AX7) from ground and connect a 680 ohm resistor and .01 mfd capacitor between it (pin 3) and ground. See Fig. 2. Remove the .001 mfd capacitor (C41) from pin 2 and ground and replace the 10 megohm resistor from pin 2 to ground (R26) with a 1.2 megohm resistor. The audio really sounds great after this simple revamping.

When I'm asked how the Two'er works I always say that the transmitter is a dream and the receiver is a nightmare. While the receiver isn't quite that bad, the broadness of the superregen circuit does make for interesting contacts when the ham down the street comes on with his 200 watts and a whole megacycle of band disappears. To make the

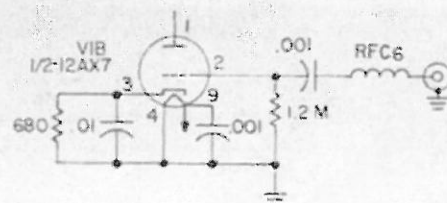

Fig. 2. Audio changes.

receiver more selective, change R10 to about 32 megohms. WN2HQE dug up the modification when he was borrowing my rig and "jerried" it in with four resistors that gave the best results. The precise value will be different for each rig but in all cases L6 will have to be retuned because the resistor(s) will change the calibration. Better yet see the June '63 issue of 73 for a fantastic improvement. You'll need a vernier after this one!

If you have a base receiver the next step in improving your two meter setup would logically be the building or buying of a converter. I've always had one switch operation and the Two'er/converter set up was no exception. One switch operation boils down to having the Two'er TR control operate a relay that changes the antenna from Two'er to converter and mutes the receiver. If contacts 2 and 3 of the Two'er's TR switch were used to activate a TPDT relay the problem would be solved.

With just a little planning, and one terminal strip, changing between using the Two'er barefoot or with a converter can be simplicity itself. Screw a 5 lug terminal strip under the mounting screw of tube socket V4 so that the strip faces the center of the chassis. Clip the lead going from contact 2 of the TR switch to the red neon light and attach it to lug 5. Clip the lead going from contact 3 of the TR switch to the power neon light and attach it, after adding a jumper wire to lug 1 of the terminal strip. Now trace out the wire going from contact 2 of the TR switch to the bottom of coil L2. Cut the wire so that there is enough lead to reach from contact 2 to lug 4 of the terminal strip. Wire a jumper on the other half of the wire and attach it to lug 5. Cut the wire going from contact 3 of the TR switch and the B+ so that the switch end will reach lug 2 and the B+ lead will reach lug 1 of the terminal strip. By using the original wiring you save the TR switch contacts from harmful resoldering. For normal transceiver operation connect lug 1 to lug 2 and lug 3 to lug 4. For a Two'er/converter combination connect the TR relay control wires to lug 2 and 4 while connecting a pair of switched contacts to lug 1 and 5. Wires to the relay can be brought

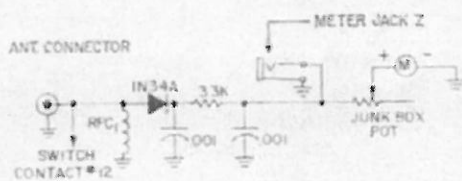

Fig. 1. Addition of tuning meter.

out through the meter jack hole or, if you want a fancy job, the eight prong power plug can be exchanged with a ten prong one and the extra contacts used for the relay setup.

You could also connect a higher B+ relay, such as a surplus 100 volt job, between the plate of the 6BS8 and ground. With this set up the internally switched B+ would activate it. If you do so WA2WZP suggests you remove the 6BS8 for best results.

By the way, a perfect place to keep the Tower mike is under the handle of the top of the case. It keeps it safe from harm yet right at hand.

The Two'er has made two meters an easy to get on band. When you build the rig though, be sure to use a small soldering iron and small solder. I built the Two'er with a gun bigger than the case and had problems getting into the corners. The one bug that kept me from getting right on the air was a real dog. The one contact that Heathkit soldered to make sure it was done "right" was cold! So be sure to check everything if something goes wrong.

The Two'er is a nice little rig and with these changes it is a real pleasure to work with.

... WA2QZH

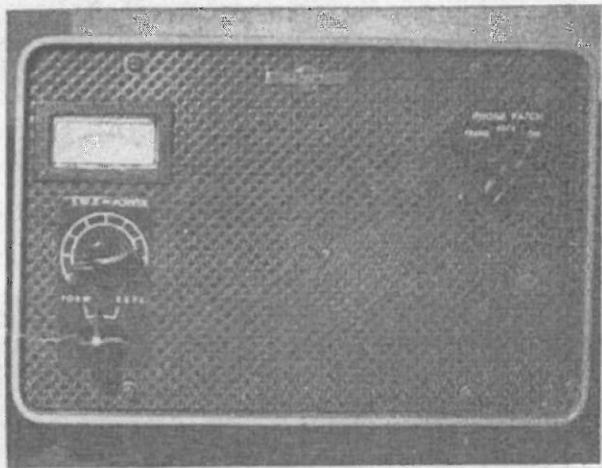

An SWR Bridge for the 32S-1

A false panel is set behind the perforated panel with a piece of black blotter between the two. The escutcheons are glued on the perforated panel with epoxy glue. On the right is a Knight SWR bridge. In the center is a 4" speaker. On the left is a Kwickpatch phone patch. Arrange the leads in the rear so the power pack can be removed without too much difficulty.

... W4NJF

SURPLUS BARGAINS SURPLUS BARGAINS

ENLARGER LENS f3.5 to f16, govt. cost \$53.00	\$3.50
LAPEL MIKE, xtl, w/cord & plug	1.35
PHONE, hearing aid type, w/cord & plug60
GEIGER COUNTER tube w/schem.	1.25
THROAT MIKE, from Air Force50
MIKE BUTTONS carbon, min. size	4/1.00
SOLAR CELL KIT, 5 cells with book	1.50
IBM FERRITE toroidal cores (memory)	200/1.00
MAT TRANSISTORS, hi-freq	5/1.00
POLARIZING FILTER (Polaroid) 6x6 inch	2/1.00
2N174 POWER TRANSISTOR 15 amp 80 volt	1.50
88 MH TOROIDS good for RTTY, etc.	2/1.00
RADIOSONDE xmtr w/tubes, new	1.25
MINE DETECTOR PRS-3, military, un- used, w/book, & Ltrys, finds treasure ..	45.00
SCOPE TUBE (CRT) 3AP1, new	1.00
SOUND POWER PHONE (2) w/100 ft wire	2.00
MINIATURE MOTOR 1.5 volt operation50
CADMIUM PHOTO CELL, make counter, nite liter	1.00
COMPUTER plug-in boards, good for parts source. Each w/transistors, re- sistors, etc.	6/1.00
REED SWITCH w/magnet, make burglar alarm	1.00
SNIPERSCOPE TUBE 6032 w/specs, see in dark	6.50
OPTICAL PRISM— pocket rainbow, new60
TOGGLE SWITCHES	4/1.00
RG 58/U COAX 52 ohm, 1000 feet.	35.00
SILICON DIODES 750 ma, 500 PIV	5/1.00
INFRA-RED DETECTOR	1.25
USA PERISCOPE PRISM 5 inch long	1.00
IR FILTER 5½ in. dia.	1.75
RDZ Military receiver, 200-400 mc, channel, 115 volt. Cost \$2,500 NEW ..	125.00
SILICON DIODES 2 amp 1,000 PIV	1.00
M-3 SNIPERSCOPE INFRA-RED see in dark	225.00

ALL MATERIAL FOB LYNN, MASS.

Above is a small selection of choice surplus from our large 72 page illustrated catalog. Send 20¢ production & handling cost for catalog.

JOHN MESHNA JR.
19 Allerton St., Lynn, Mass.

Frank Gallinelli K1GHO
758 Summer St.
Stamford, Conn.

SIXER to the Nth

The Heathkit Sixers and Twoers are well known as fine and flexible pieces of gear. With a few additions and modifications, however, a good deal more operating ease and efficiency can be obtained from these rigs.

Power Supply

Going first to the power supply, I found that the trouble-free operation enjoyed at the home QTH had a habit of literally going up in smoke in the mobile. The problem is quickly and permanently solved by replacing the diodes with International Rectifier type SD-92.

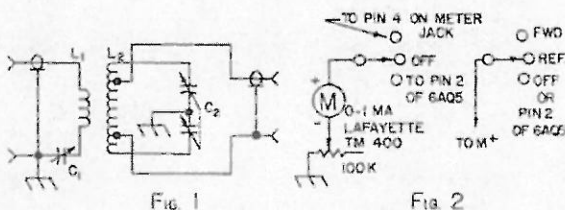
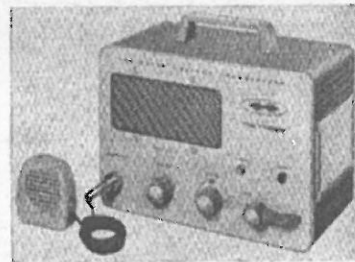

Fig. 1. Coupler diagram.

Fig. 2. Two of the possible switch combinations, using three position rotary. If spdt toggle switch is used instead, an off position is recommended.

C1-100 mmfd variable for 50 mc, 50 mmfd for 144 mc (Hammarlund MC100, MC50)
C2-35 mmfd per-section split stator variable, .07" spacing (MCD-35SX). Reduce to 4 stator and 4 rotor plates per section in 144 mc coupler for easier tuning.
L1-50 mc: 4 turns, #18 tinned, 1" diameter, 1/8" spacing. (Air-Dux #808T)
144 mc: 2 turns #14 enam., 1" dia., 1/8" spacing. Slip over L2 before mounting.
L2-50 mc: 7 turns #14 tinned, 1 1/2" diameter, 1/4" spacing (Air-Dux #1204). Tap 1 1/2 turns from each end.
144 mc: 5 turns #12 tinned, 1/2" diameter, 7/8" long. Tap 1 1/2 turns from each end.



Receiver

The Sixer receiver, as known to anyone who has ever used a super-regen, is not the epitome in receiving excellence. More than one normally timid soul has been moved to acts of violence during a band opening thanks to its lack of selectivity. Efforts to relieve this situation electrically did not bear enough fruit to merit mention. Mechanically, however, I have found that a 2" vernier dial (Lafayette F-347) (99c) is of considerable help to the poor OM with coffee nerves who can't tune the ungeared dial onto the best side of the squealing signal. Two months of tinkering convinced me that the tuning condenser should not be pushed back into the rig. Success was finally achieved by cutting the condenser shaft, leaving only about 1/8" protruding from the panel surface, and cutting the vernier dial shaft through the set-screw hole. Mount the dial without the top mounting screw or set screw and you're set. The pressure of the dial on the condenser has held everything in place perfectly for me, but if any slipping is experienced, a drop of glue (or chewing gum maybe?) will hold it tight. Due to different design, this mounting system is not applicable to the Twoer.

The only other addition to the receiver was a closed-circuit phone jack mounted in the upper left-hand corner of the panel and wired in series with the hot lead to the speaker.

Transmitter

The transmitter was attacked next, and, if you'll pardon my Caesar, *utrinque acriter pugnatum est*.¹ Having become fed up with futile attempts to tune the tank without removing the rig from the case, I first devised an external tuning method. Start by soldering the threaded sleeve from an H. H. Smith type 105 phone tip to the screw head on the ceramic trimmer. Next scrounge for a screw (approximately 3/8" in length) that will fit the sleeve and replace

¹ Translation: "It was fought fiercely on both sides."

17

Just a Piece of Wire?



One hundred feet of Saxton economy twinlead sells for just a dollar. To make that twinlead we first have to melt copper ingots and extrude coarse copper wire. This then is drawn finer and finer to the finished size we need. Next this wire is wound into seven strand wire and then this is fed into a sickeningly expensive machine that forms the polyethelene and exactly spaces the wires in it, exactly gauges the thickness of the polyethelene, and automatically inspects the twinlead for any possible defect. You buy this for a penny a foot. We won't even try to tell you about the months we worked designing this twinlead, the lab tests, the pilot runs, the unbelievable stuff that came out of the first machines we tried to built, and the months we spent making sure that our twinlead was a product we could be proud of.

We've been through this sixteen times now with our 16 different types of twinlead, seventeen times with coax, nine times with open wire line and on and on for our hundreds of types of wire and cable.

You'll specify Saxton?

SAXTON

215 NORTH ROUTE 303
CONGERS, N. Y.
914 CO 8-6846

its head with a small knob. Finally, mount a rubber grommet in one of the air holes opposite the trimmer. Simply push the "screw-knob" through the grommet, and screw it into the sleeve. All this nonsense will give continuous clockwise and limited counterclockwise rotation of the condenser.

Undoubtedly the smartest thing I did all week was to add an antenna coupler to the Sixer. For the benefit of anyone too cheap to own a *Handbook*, the schematic, adapted for coaxial output, is reproduced here. This innocent looking gadget, built into a 3" x 4" x 5" grey hammertone box, will load into practically anything; in fact K2LLC used it to load his Poly-Comm 62B into a window screen with a 1:1 swr. You should find it particularly useful in the mobile, where standing waves often run amuck. If used in conjunction with a low pass filter, it should be mounted on the left side of the rig with the filter screwed onto the case at one end and onto the coupler (with a spacer) at the other.

Naturally, some method was needed for adjusting the coupler. No problem. Mount a 0-1 ma meter, a 100,000 ohm pot, and a spdt toggle or three position rotary switch as shown in the photo. The popular little "Monimatch" swr bridge should fit nicely inside the coupler

box, with phone tips coming from the switch, through the air holes near the coupler, and into jacks on the box. Or, if you're as lazy as I am, you can do what I did: monitor the so-called "power output" device in the Sixer or Twoer (tuning C1 on the coupler for maximum and C2 for minimum), and use the other switch position to monitor the "kick" in your modulation. Or you can monitor the filament current and pilot-lamp voltage and say the heck with the coupler.

Operating convenience was jacked up one last notch with the addition of a crystal socket on the front panel (see photo). Simply run shielded leads from the panel socket and plug them into the chassis socket.

When the smoke cleared, I decided to rewire the transmitter section with shielded grid wire. The apparent increases in harmonic suppression and circuit efficiency were more than worth the effort (the neighbors got off my back and the dummy load burned out).

Finally, I replaced the Sixer's 6CL6 final with a 5763, which squeezed another watt or two of rf out of my Benton Harbor Kilowatt. Don't forget to rewire the tube socket.

That about sums it up. By now, your Sixer or Twoer should be operating more efficiently than ever.

. . . KIGHO

Two'er Talk

During the past 4 years, I have had occasion to chat on 144 mc with several stations using Heath TWOers. Some of these useful little transceivers deliver excellent results for their owners. There are, however, a number of these TWOers which are suffering from transmitter instability, TVI, bassy audio, abnormally low output and audio distortion. A few of these ills are caused by poor workmanship when the kit was assembled. The bulk of the ailments mentioned result from engineering problems which can quite readily be corrected.

Numerous articles have been written and dedicated to circuit modification of these handy little portable packages. Little has been said about the more predominant problems which exist in them. Some of these articles described the addition of push-to-talk relays, panel meters, squelch circuits, etc. The basic ailments which relate to efficient operation have not been presented. While sitting back on the sidelines, watching many of the fellows struggle with these common problems, I decided to acquire a TWOer of my own and attempt to resolve these more troublesome circuit bugs. After studying the circuit diagram, applying standard procedures and sweating over a moderately hot soldering iron for a short period of time, I ended up with a TWOER which possessed all of the attributes common to a well engineered VHF transmitter.

Analysis

The final tank circuit could be modified to provide much greater efficiency and reduced TVI.

The P.A. stage would no doubt benefit from neutralization inasmuch as both the driver and P.A. are in a common envelope, operating on the same frequency.

Capacitor values in the speech amplifier and modulator stages could be changed to reduce bass response and give the signal greater "punch."

High level-negative peak clipping could easily be added, to further increase audio punch and aid in the elimination of possible "overmodulation."

Conventional coax fittings could be added to the rear apron of the TWOer, to facilitate use with other station equipment and antenna feedlines.

Removal of the diode metering circuit could prevent bleeding of rf power from the transmitter output and reduce TVI caused by the harmonic action typical with diodes.

With great enthusiasm, the above changes were made. The results were well worth the small amount of effort.

The Modifications

P. A. Tank—Replace the final amplifier tank coil with 4 turns of #12 wire, $\frac{1}{2}$ " in diameter \times 1" long. (Silver plate if possible.)

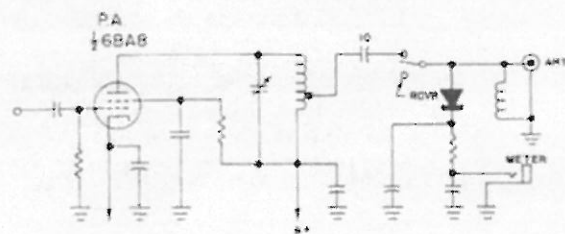

FIG. 1-A

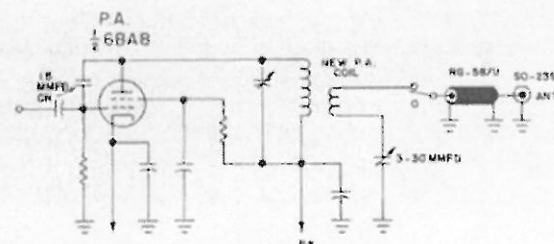

FIG. 1-B

Remove the 10 mmfd output coupling capacitor from the P.A. Tank coil. (This will reduce TVI and permit a better match to the feedline.) Replace the capacitive output circuit with a 2 turn link of #20 formvar or nyclad wire, inserted in the B+ end of the new tank coil. (Make certain the link is wound in the same direction as the tank coil.) Return this new link to ground through a 3-30 mmfd mica trimmer. This will be used to effect a proper match to the feedline and reduce reactance.

Replace the bus wire connecting the antenna fitting to the TRANSMIT-RECEIVE switch with a short length of RG-58/U coaxial cable. Be sure to ground the shield at both ends of the new cable. (See Fig. 1-B.) This further improves feedline matching and circuit isolation.

Neutralization of the P.A. Stage—Due to the self neutralization frequency of the 6B8B

19

P.A. tube, it became necessary to employ POSITIVE neutralization. This is actually less complicated than the conventional methods of neutralization. Add a 1.5 mmfd ceramic capacitor from pin 7 to pin 9 at the tube socket, keeping the pigtails as short as possible.

This modification eliminated all signs of instability, cleared up all signs of FM, downward modulation and audio distortion and roughness. TBI was further reduced until it could no longer wipe out channel 7. Faint cross hatch remained. (See Fig. 1-B.)

Replace the .01 mfd coupling capacitor between the 12AX7 plate pin and the 6AQ5 control grid, with a .005 mfd disc ceramic. Replace the 25 mfd cathode by-pass electrolytic on the 12AX7 stage, with a 10 mfd 25 volt unit. Replace the .01 mfd 3 KV by-pass condenser connected from the modulation transformer tap to ground, with a .005 mfd 3 KV ceramic unit. These changes resulted in better high frequency characteristics in the audio system. Readability under weak signal conditions was improved. (See Fig. 2-B.)

Clipping—There is no audio gain control for the modulator. This means that it is necessary to remain a proper distance away from the microphone to prevent "overmodulation." This can be a source of annoyance when operating mobile. This extra audio which is available, can be put to use in the form of "clipped modulation" which will increase the weak signal readability of the transmitted signal. To add this High Level Negative Peak Clipping, simply add a 500 ma top hat type silicon diode to the modulator output circuit, as shown in Fig. 2-B. You can now "move in" on the mike without fear of distortion, etc.

Antenna Fittings—Replacement of the present antenna connector with a standard SO-239 chassis type receptacle, will permit use with standard cables and other station accessories. This is easily done by enlarging the existing mounting hole with a 3/8" chassis punch.

Metering Circuit—In some TWOers I have tested I discovered that the metering diode and allied circuitry bled a portion of the rf output energy away from the feedline. Removal of the entire network increased the transmitter output considerably. In addition, the metering diode encouraged harmonic output, which in turn contributed to TVI. Once this circuitry was removed, the remaining TVI disappeared. Without this metering provision, it becomes necessary to tune up by a different means. In my case, I tune for maximum forward power as noted on my SWR bridge. This should be no handicap, inasmuch as most well equipped VHF stations have an

SWR bridge as standard bill of fare.

Conclusion

Before modification of the circuitry, as noted above, the measured output of the TWOer was .78 watts. Similar readings were taken with other TWOers. Following modification, the output increased to 2.4 watts into the same dummy load. No trace of TVI could be found. Prior to modification, channel 7 was wiped out. Reports of excellent audio quality and quantity were received following the circuit changes.

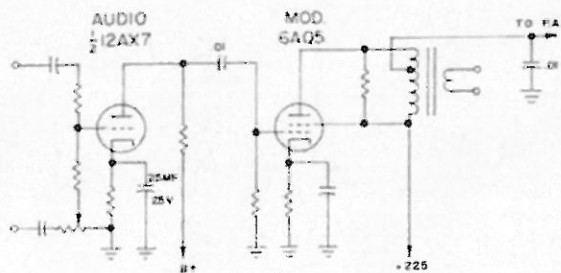

FIG. 2

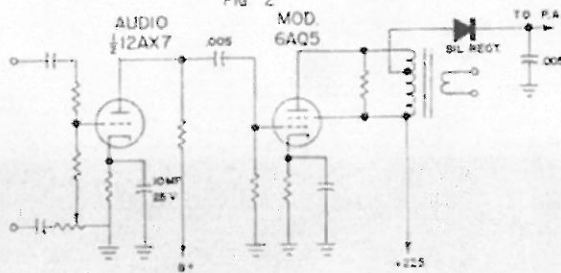

FIG. 2B

Regardless of the manner in which the multiplier stages and the P.A. are tuned, no instability would occur. Audio distortion and downward modulation completely disappeared.

Other refinements could have been made to the TWOer, but the ones mentioned in this article were of greater importance.

No changes were necessary in the receiver portion of the transceiver. Having built several regen type 2 meter receivers, I must say that the one contained in the Heath TWOer is the best I have seen in such simple circuitry. It is stable, sensitive and exhibits no "dead spots" in the tuning range.

With my modified TWOer, I have been able to work considerable distances over the rough terrain common to Northwestern Lower Michigan. I am using stacked A-62 Finco antennas on a 75 foot tower and feeding them with low loss balanced feedline and a VHF type Matchbox. I have been able to hold regular Q-5 schedules with WA9DOT in Grafton, Wisconsin. The distance is 165 miles, airline. Other similar contacts have been made without the aid of band openings.

Good luck on your TWOer changes!

... WSHHS

Operating Suggestions For The Two'er

E. H. Marriner W6BLZ
528 Colima Street
La Jolla, California

There have been numerous suggestions for improving the two meter Heathkit HW-30 transmitter-receiver also known as the Two'er. Here are some more suggestions.

In order to change crystal frequency it is necessary to remove the cabinet. The crystal originally is inside. A socket could be mounted on the front panel to remedy the situation, however, the long leads back to the original socket add so much capacity and inductance that the crystal may no longer oscillate. Some operators have solved the problem by cutting a square hole in the side of the cabinet. A better solution is to mount the crystal socket vertical at the back of the cabinet, and it does not take up much more space. A new .001 disk capacitor and a 22K 1 watt resistor will be needed because the new leads need to be slightly longer than the original components. To mount the crystal in the vertical position requires disk sanding a double type crystal socket down to the center hole. In other words do not cut the socket exactly in half. A number 41 drill hole is required

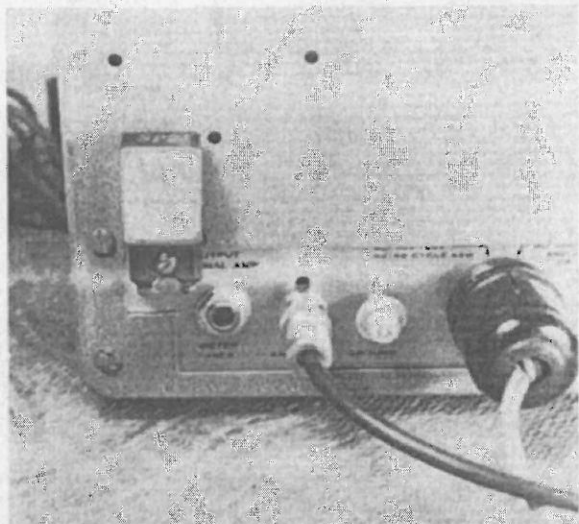

Mounting the crystal socket and the BNC coax socket.

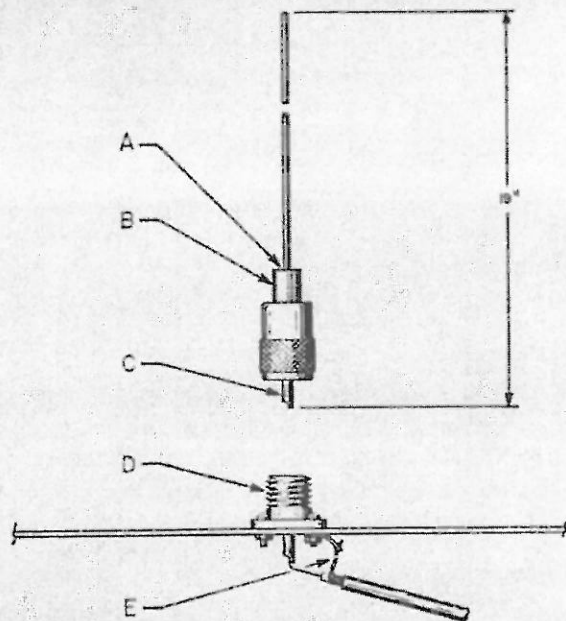

Fig. 1. Two meter antenna made from a type SO VHF coax plug.

A. use a number 41 drill through the nylon center to accept the rod. B. $\frac{3}{8} \times 1$ " nylon slipped over rod after soldering. C. Brass rod pushed in and soldered here. D. Plug installed on top of the Two'er cabinet. E. Coax braid soldered to lug.

through the side of the socket to fasten it to the back of the chassis. A dab of Armstrong cement will help the screw secure the socket in a solid position. Two tiny holes are now drilled through the chassis for the leads of the 22K and .001 mfd capacitor whose leads have been covered with Teflon type spaghetti insulation to prevent shorting of the leads to the chassis. To change crystals now only requires peering around the corner of the cabinet to pull the crystal out and to plug in another.

Another improvement to the Two'er is to replace the phono type rf output socket with

21

Frequency	Crystal
144.000	8000 ke/s
144.18	8010 ke/s
144.45	8025 ke/s
144.7	8040 ke/s
144.9	8050 ke/s
145.31	8073 ke/s
145.35	8075 ke/s
145.440	8080 ke/s
145.500	8083.3 ke/s
145.620	8090 ke/s
145.800	8100 ke/s
145.900	8106 ke/s
146.000	8111 ke/s
146.090	8116.7 ke/s
146.200	8225 ke/s
146.500	8140 ke/s
146.700	8150 ke/s
146.820	8156.6 ke/s
147.1	8173 ke/s
147.2	8175 ke/s
147.6	8200 ke/s
148.00	8227 ke/s

a BNC chassis mount type. This will make it easier to change the RG58/U antenna cable. To put in this fitting the hole will have to be enlarged to $\frac{3}{8}$ inches and the fitting will push in and the nut can be fastened to the underside of the chassis.

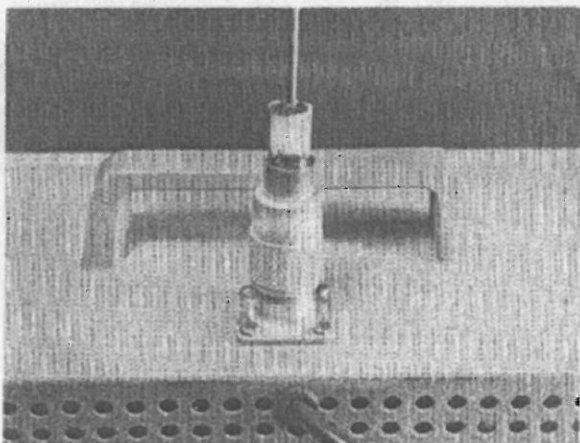

Mounting the portable antenna on the Two'er cabinet.

For portable operation in the backyard or on the dining room table, a vertical 19 inch whip antenna can be made and mounted on top of the cabinet. (see Fig. 1) It is only necessary to punch a $\frac{3}{8}$ inch hole on the top of the cabinet and then solder on a short piece of RG58/U, and push it out one of the vent holes at the back of the cabinet. Now attach a BNC type fitting to the short lead and push it in the new BNC chassis fitting. The antennas can be

made from a piece of brazing rod which is pushed through a piece of nylon insulation and is later pushed down into the SO type fitting and cemented after the rod has been soldered to the plug pin.

Each time a new antenna is used on the set the final will have to be adjusted for maximum output a fact often overlooked by operators because the ceramic output capacitor is inside the cabinet. A small hole can be drilled on the side of the cabinet so that a tuning wand* can be inserted to tune the final amplifier while watching the 0-1 mA output meter plugged into the back of the cabinet.

While these suggestions may seem trivial, they may be of great help to the person not familiar with the two'er, and they certainly make operating of the two'er much easier.

. . . W6BLZ

**Please use
your Zip Code
when writing 73**

Ver-r-r-y Inter-r-r-esting Bargains!!!

Send for our ver-r-r-y inter-r-r-esting 68 page catalog !!! 23c (Free with an order !!!)

P.P. = POSTAGE PAID

D. C. to 400 CYCLE POWER SUPPLY KIT

This is an indispensable item if you want to run Gov't Surplus aircraft or missile electronics. It will convert 12VDC or 6VDC to 110 volts, 400 cycle 35 watts. The kit includes a high quality potted transformer, transistors, resistors, diodes and instructions. No hardware or cabinet is provided. The output waveform is square, rather than sinusoidal, but our experience has been that this will not make any difference since military equip. is insensitive to waveform distortion. Wt. 3 lb. 400 Hz P.S. \$3.50



SILICON RECTIFIER AND HEAT SINK ASSEMBLY — 4 for \$2.50

This is by far the best rectifier deal we have ever offered. Four heat sinks each containing two Motorola or Delco I N 3651 25 ampere 200 PIV rectifiers. These are not factory rejects but unused termination material. With the four assemblies containing eight (8) diodes you can make either one 50 ampere bridge, two 25 AMP bridges, or four 25 AMP full wave center tapped rectifiers. Comp. w/inst. 4SRHS \$2.50 P.P.

1000 MED TANTALUM CAPACITOR
Buy a brand new high capacitance Tantalum Capacitor for less than the price of an equivalent aluminum foil unit. You gain the advantages of small size, high reliability, infinite life, and high temperature operation. Don't let the Electrolytic Capacitor be the largest size and least reliable component in the next home project or replacement. Regular net price of these units is \$72.00. Brand new.
Tantalum Capacitor 1000 Mfd @ 50 VDC TC'000 \$2.00 P.P.
400 Mfd @ 75 VDC TC 400 \$2.00 P.P.

B & F ENTERPRISES
P.O. BOX 44, HATHORNE, MASS. 01937

22

Push to Talk

(The Twoer Way)

Norm Ross VE3ETJ
Box 26, R.R. 1
Dorchester, Ont., Canada

It all started one bad winter day. I was giving road conditions in our area to another local ham when I reached to push down the transmit switch on the twoer. At the same time another car was coming in the opposite direction. The twoer, being out of arm's reach, made me lean over to transmit. This made the car sway towards the oncoming car. If the driver had not headed for the ditch there would have been a real accident. With my heart in my mouth, this brought me to the conclusion that we needed push to talk.

We did it inexpensively without defacing the Twoer in any way. One evening will do the job, and if you have the assembly manual of the Twoer (HW 30), assembly will be much faster when installing the relay.

Step 1.

The relay which we used was a Potter & Brumfield KHP-17All-12 volt (4 P.D.T.) The relay is mounted upside down between coil CC and socket V4. To hold the relay down in place, a bracket was made and attached to the mounting screw of the relay. When the bracket is attached, move the wiring out of the way between the coil CC and socket V4 and place it so that the bottom of the bracket is below coil CC and the relay about 1/4 inch away from the coil. Drill a 5/32 hole and fasten to the chassis.

Step 2.

Now the wiring begins:

At any time you find the original wiring is too short, replace it keeping all the wires close to the chassis when transferring from wafer switch Z to relay. Start transferring the wiring at pin 12 of the wafer switch Z to pin 9 of the relay.

From Wafer switch Z	To: Relay
12	9
11	5
10	1
9	10
8	6
7	2
5	7
4	3

Pins 6, 3 and 2 are left connected to wafer switch Z.

Pin 11 on the relay is grounded.

Pin 12 on the relay is connected to pin 3 of wafer switch Z.

Pin 8 on the relay is connected to pin 2 on coil CD.

Connect a .01 disc capacitor from pin 6 to pin 11 on relay.

Step 3.

Now that the relay has been wired in, we need a voltage to operate the relay coil. I wired in a half wave power supply and filtered it just enough to close the relay. (If relay does not close, take the tension of the spring until it does close.)

The power supply was made on a four pin terminal strip (PS) using a 50 mfd. at 50 volts condenser and a diode. Place this strip under the screw that holds V3 in place coming from pin 1 of the terminal strip S which has a RFC to pin 5 of V3 (6BS8) filament supply. At this point the relay voltage was taken. Drill a 1/4 in. hole near pin 1 of terminal strip S. Connect a wire from pin 1 of S to pin 2 of PS. Connect a jumper from pin 1 to pin 3 of PS. Connect a 50 mfd. 50 volt condenser from pin 1 (neg.) to pin 4 (pos.) of PS.

Connect a wire from pin 4 of PS to pin 13 of the relay.

Step 4.

All that's left is the microphone connection. Replace the mic. connector 432-3 with any 4 pin female connector. Pins 3-4 of the connector are grounded. Pin 2 goes to RFC coming from pin 1 of V1. Pin 1 goes to pin 14 of relay. Connect jumper from pin 14 of relay to pin 5 of wafer switch Z. For the mic. cord we used an Armaco TFCC and the mic. was a ceramic with push button. The old transmit switch will still work as if nothing had been changed, except we don't have to reach down and fumble with the switch. We have a tener with the same modification, now all THREE of us are doing fine!

... VE3ETJ

Twoer Modifications

Ernest Jay Wolitzer K2ORY
2143—82nd Street
Brooklyn 14, N. Y.

Photo credit: Elliot Eckhaus, K2GUL.

THE Heath transceiver units, commonly known as the Tener, Sixer & Twoer are excellent units in regard to operation, size, and cost. This article is based on the Twoer, but will hold the same for the others.

The Twoer was used in the home QTH for a while, and I became interested in using the rig mobile. As some of us might know, setting up a mobile rig takes time and most of all, patience.

In the Twoer, described here, I did away with all of the hard work, such as running cables, mounting power supplies, etc. The unit now will operate either 110 vac or 12 vdc at the flip of a switch.

If ever it came to mind to use a VFO, you would probably not be too successful, because with the original oscillator circuit a VFO could not work. I made some minor oscillator changes that helped to stabilize the unit when

a crystal was used, and now I can use a VFO.

Construction Details

The fuse holder in the rear of the unit was removed and mounted in the space that had originally been used for the eight pin power plug. The hole that was used for the fuse is now the mounting hole for the new switch.

Part of the power supply is built on a sub-chassis which is mounted on the speaker baffle plate. This sub-chassis, measuring 3 1/2 in. L. by 2 1/4 in. W., is made of a piece of 1/8 in. steel. A 1/2 in. lip is bent and used for mounting.

The silicon diodes and the rest of the power supply components are wired on a terminal strip, which is then mounted on the screw that holds the power transformer. The four prong power plug is mounted on brackets, and is positioned near the output transformer. It will be found that in order to have access to the

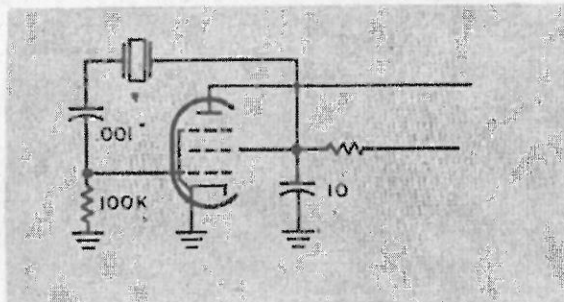

Before

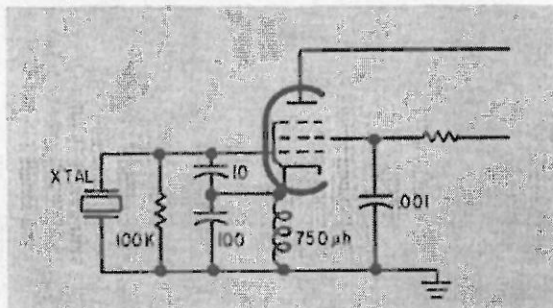

After

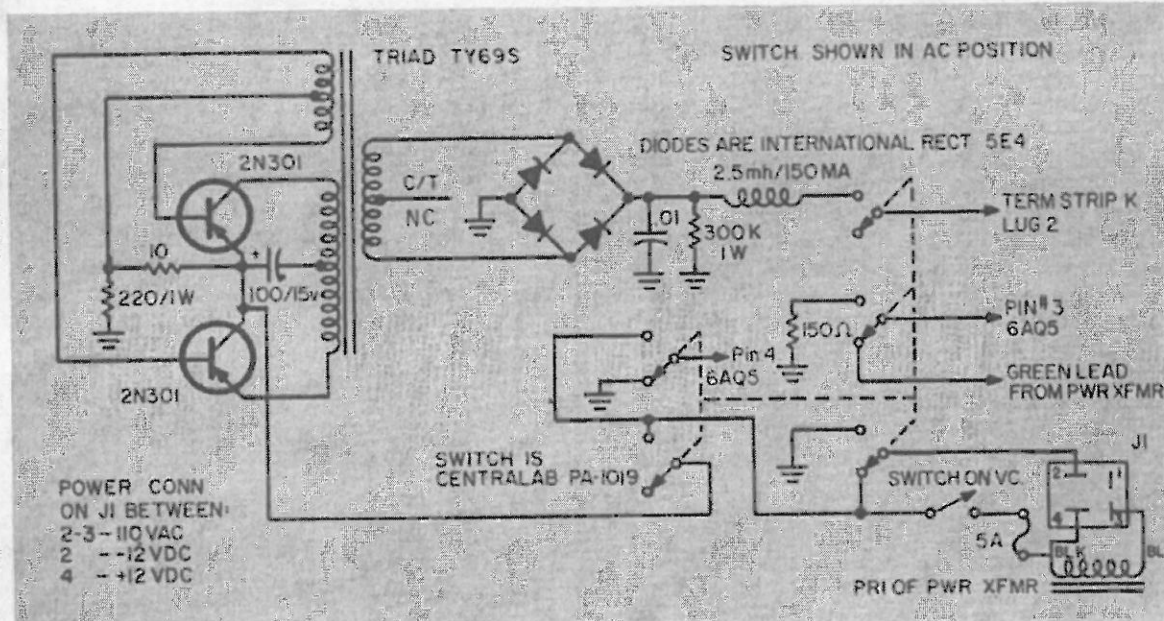

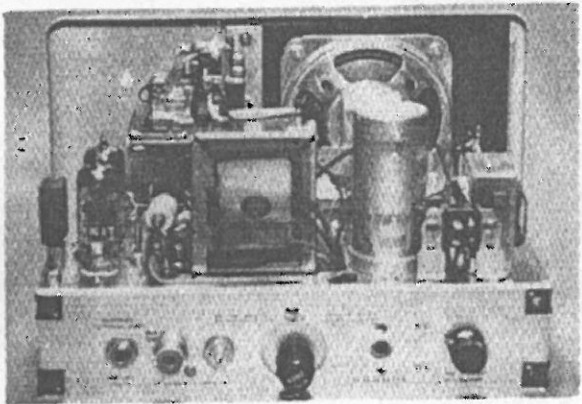

This picture shows the new location of the fuse, switch, and four prong plug. It also shows how power supply is mounted on the speaker baffle plate.

power plug when the cabinet is installed, you will have to cut a hole in the rear.

Operation

The new selector switch is used to select either ac or dc operation. For operating on 110 v, connect pins 2 and 3 to the power source. One 12 v., where the power can be taken from the car's cigarette lighter, connect pin 2 to -12 v and +12 v to pin 4 of J 1.

We found that when operating mobile, lowering the broadcast antenna to approximately 19 in. worked fairly well. . . . K2ORY

8 mc Xtal Multiplications

6M (x2 x3) (x6)	(2M) (x2 x3 x3) (x18)
50 mc == 8333.333	144.0 mc == 8000.000
50.1	8055.555
51	8111.111
52	8166.666
53	8216.666
54	8222.222
114M (x3 x3 x3) (x27)	54M (x2 x3 x3 x3) (x54)
220 mc == 8148.148	420 mc == 7777.777
221	7870.370
222	7962.962
223	8000.000
224	8055.555
225	8148.148
	8240.740
	8333.333
	450

. . . W4OAB

TONS OF AMATEUR EQUIPMENT IN STOCK

WESTERN RADIO

SAN DIEGO

1331 India Street BE 9-0361

MON - FRI 8:30 to 8:00 SAT 8:30 to 5:00

IMPEDANCE BRIDGE Complete Instructions (August 1961 issue of 73)

14 full scale diagrams of the parts necessary for this replica of a \$350 General Radio RF Impedance Bridge. Complete with reprint of the original article. \$1.00

73 • 1379 E. 15th St. • Brooklyn 30 • N. Y.

NEW FOR SIX & TWO!

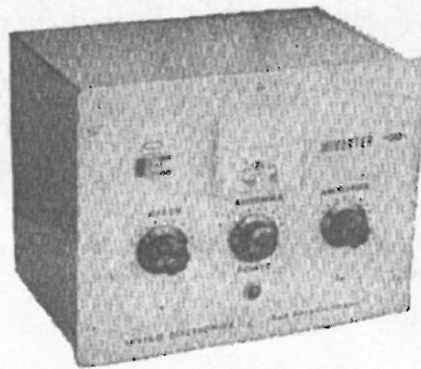

HIVERTER 50

Extends use of your present 14 Mc SSB, AM and CW Transmitter to 50 Mc Band

Tubes: 6CL6 Oscillator, 5763 Mixer, and 6146 Linear Amp., with 2-0B-2 Regulators.

PI-Net Output to match 50-100 ohm Antenna Load

Cabinet Size: 8" x 7" x 10"

Power Supply Requirements; (Heathkit HP-20 or similar)
 6.3 V. AC-2.7 Amps (Filaments)
 300 V. DC-60 Ma. (Osc.-Mixer)
 600 V. DC-120 Ma. (Amplifier)
 -130 V. DC-(Amp. Bias)

PREVERTER 50 & 144



Uses Low noise Philco Transistor - Less than 3 Db on 6M, 3.5 Db on 2M

Efficient - Requires 1.25 Ma at 12 V. DC

Input and output 50 Ohm, with connectors for RG 8/U Bandpass circuitry gives full 4 Mc response on both Bands.

Rugged and Low loss construction with silver plated chassis and input circuits.

WRITE FOR COMPLETE INFORMATION

- HIVERTER-COMplete WITH TUBES AND CRYSTAL, LESS POWER SUPPLY.....\$99.50
- 3 Db PAD-FOR 20-50 WATT EXCITERS.....\$ 6.00
- 6 Db PAD-FOR 50-100 WATT EXCITERS.....\$10.50
- PREVERTER 50-6 METER PREAMP.....\$14.95
- PREVERTER 144-2 METER PREAMP.....\$14.95

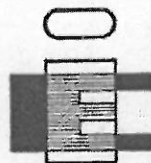

Irving Electronics

P. O. Box 9222

San Antonio 4, Texas

25

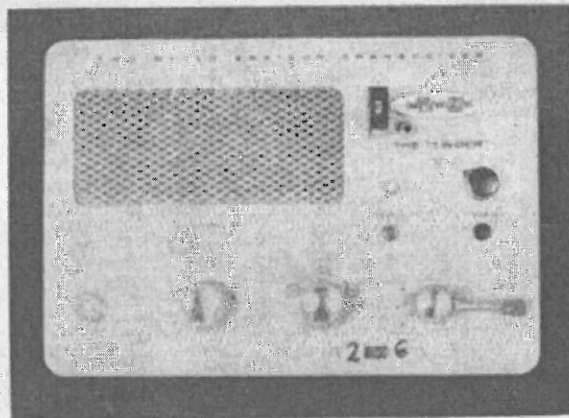

The Twixer

Add six to your Two'er

After building a simplified 6 meter version of KSKDX/6's 6 and 2 meter portable¹, I became intrigued with the idea of adding 6 meter (50 to 52 mc.) coverage to my Heathkit Two'er.

It was desirable to get a rig which used as much of the Two'er's circuits as possible. Fortunately, by reworking the power supply a bit, one section of the Tx/Rx switch was freed to be used to switch the 6 meter antenna. The Tx/Rx switch will now serve whichever rig is on. Band switching is done in the filament line, and the tubes are wired to allow for 6 or 12 volt operation. The result of this article is a 6 and 2 meter rig in the Two'er case. Handy!

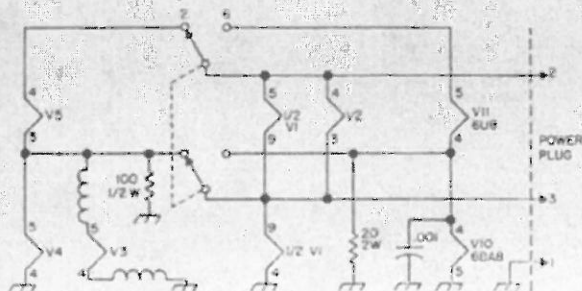

Fig. 1. Rewiring of the Two'er filaments.

The receiver uses a 6U8, the triode half as a super-regenerative detector, the pentode half as an RF amplifier. The regeneration pot on the rear apron controls either the Two'er's detector or the new 6 meter detector. In my unit, setting the pot on 2 meters proved to be satisfactory on 6 also. The Two'er detector plate choke is now common to both bands as is the audio section.

The triode half of a 6BA8 function as a third-overtone oscillator to drive the pentode half which doubles to 6 meters. This allows the use of 8 mc crystals. I have found this transmitter to be quite adequate for local work. The Two'er audio section supplies modulation in transmit.

Changes

The addition and changes were done in four parts.

PART I Filaments and filament switch.

- 1) Add the dpdt slide switch between and below the Two'er tuning capacitor and Tx/Rx switch. Be sure this switch will clear the variable capacitor and the outside case.
- 2) Wire the Two'er filaments (as shown in

¹ 73, March 1963, page 52. *A Six and Two Portable.*

26

The Radio Society of Great Britain Amateur Radio Handbook

This fabulous 540 page hardbound handbook completely and thoroughly covers every aspect of amateur radio; tubes, transistors, receivers, transmitters, vhf gear, antennas, side-band, FM, mobile equipment, noise and interference, propagation, keying, modulation, power supplies, measurements, operating and station layout and much, much more. It is completely illustrated with photographs and drawings. This handbook is very well written and completely understandable. The RSGB tries to help hams improve themselves, so it includes much necessary technical data that some American handbooks ignore. For instance, suppose you want to design a linear for SSB. The Brand X Handbook devotes about four pages to description, including a table of typical values of popular tubes. The RSGB Handbook gives 13 pages to them, plus many pages of construction, figuring bias, resting current, circuit constants, efficiency, etc. The RSGB Handbook is a necessity for the building, technically minded ham. Even if you don't build, this book will help you understand your equipment and radio better. In stock for immediate delivery if you order now. **\$5.50**

THE AMATEUR RADIO HANDBOOK



AN RSGB PUBLICATION

The RSGB Radio Data Reference Book

This Reference Book is the best we've seen. It has just about everything you want to look up in it. It gives you all of the formulas missing from your Brand X Handbook. All of the formulas, graphs and tables you'll ever need on RF power amplifiers, pi nets, tanks, filters, antenna design, coils math, etc. are in this one book. It's hardbound with traditional English quality, so won't fall apart after a few months use as paper-bound books sometimes do. If you build, if you want to be able to use your equipment properly, you need this book. In stock if you hurry. **only \$2.25**

The RSGB Amateur Radio Circuits Book

Suppose you want to build something. Are you going to have to look through dozens of books and old magazines to find a schematic? Not if you have the RSGB Amateur Radio Circuits Book. It gives you almost all the schematics you might need in one convenient handbook that has a special durable ring binding that permits it to lie open while you work. This book covers tubes and semi-conductors, receivers, transmitters, power supplies, antennas, etc. In stock if you order now. **only \$1.75**

73 Magazine

Peterborough, N.H. 03458

- 5) Install the .001 μ f capacitor at L10. Also run a 22k resistor to lug 2 of terminal AA.
- 6) Run the other end of the .001 μ f capacitor to the crystal socket. Also put in the 50 pf capacitor.

PART 4 New subchassis.

- 1) Make the new subchassis as shown in Fig. 5. The $\frac{1}{2}$ inch lip will have to be notched to fit around V4. The panel should be bolted in $1\frac{1}{8}$ inches from the Two'er front panel, after it is wired.

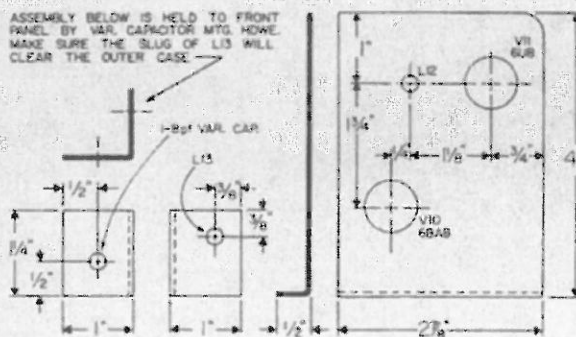

Fig. 4, left. Details of capacitor and coil tuning assembly.

Fig. 5, right. Details of the new subassembly. Front view of the Twixer.

- 2) Install sockets for V10 and V11.
- 3) Wire up the sockets. All leads going to front panel controls, or to the Two'er circuit, should be left long enough.
- 4) Put the panel in place and drill convenient holes for mounting. Also drill holes for running the wires from this assembly through the Two'er chassis.
- 5) Make a strap to secure the upper end of this assembly to the front panel.
- 6) Secure all the loose leads from the new assembly (see Fig. 3).

TESTING

- 1) Put the filament switch in the 6 meter position. Turn on the power. If the filaments light, and there is no smoke, adjust the Two'er regeneration control of the regenerative hiss. Adjust L13 to get the tuning range to 6 meters. On a weak signal peak L12.
- 2) Plug a 8 mc crystal for 6 meters into the new crystal socket. Put the Tx/Rx switch in the Tx position. Adjust L10 for maximum output (use a grid dipper in the diode position) at 24 mc. Adjust the 3-15 pf capacitor for maximum 50 mc output (use a small pilot lamp for a dummy load). That's it. You now have a Twixer Two'er.

... WØHMQ